

ELEVATION

SECTION 'DD'

N.O.C - ISSUED

VIDE FILE NO: M/18236/96
 DATED: 30.4.1997

LABS DN: 10
 NOC: 97

FOR MEMBER SECRETARY
 C.M.D.A., CHENNAI-600 008

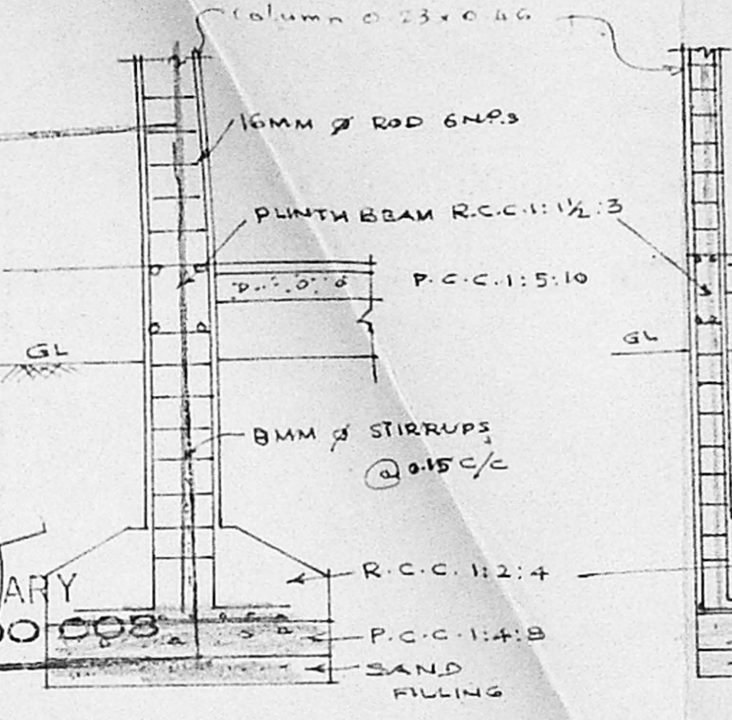

FOUNDATION DETAILS

CMDA 'C' APP No. 1
 02/1503/92

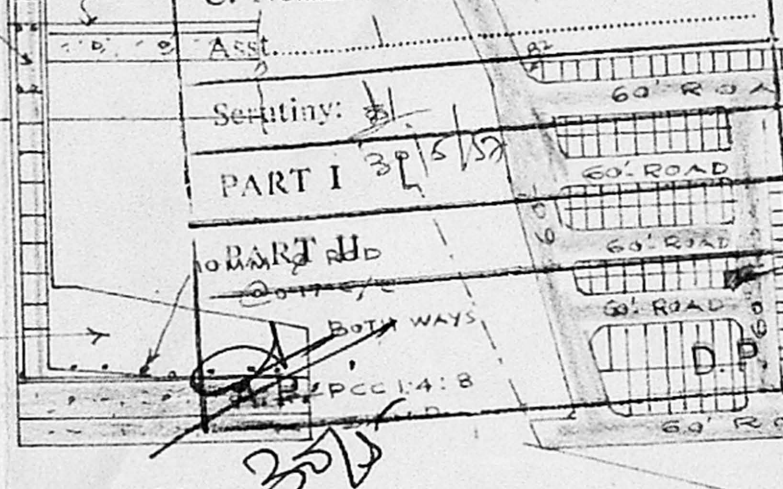

KEY PLAN

NOT TO SCALE

PLAN SHOWING THE PROPOSED OFFICE CUM GODOWN BUILDING IN PLOT NO. D-1, S.NO: 811/1 Part BUS & TRUCK TERMINALS AT MADAVARAM VILLAGE CHENGAI - M.G.R. DISTRICT.

SCALE: 1:100 1:200

JOINERIES

| | | |
|-----|-----------------|-------------|
| RS1 | ROLLING SHUTTER | 3.05 x 2.42 |
| RS2 | - DO - | 1.83 x 2.42 |
| D | DOOR | 0.91 x 2.10 |
| D1 | - DO - | 0.75 x 1.98 |
| W | WINDOW | 1.52 x 1.37 |
| V | VENTILATOR | 0.51 x 0.45 |
| V1 | WINDOW | 0.51 x 1.37 |

AREA

| | |
|-------------------|-----------------------|
| PLOT EXTENT | 107.28 m ² |
| GROUND FLOOR | 53.9 m ² |
| FIRST FLOOR | 53.9 m ² |
| PLOT COVERAGE | 50.24% |
| FLOOR SPACE INDEX | 1.005 |

COLOUR

| | |
|---------------|-----------|
| PROPOSED WORK | [Pattern] |
| BOUNDARY | [Pattern] |
| ROAD | [Pattern] |
| SEWER LINE | [Pattern] |

OWNER SIGNATURE

T. Castoury
 T. CASTOURY, D.C.E., D.C.T. & C.S.,
 CIVIL ENGINEER
 Licensed Surveyor
 Corporation of Madras
 No: 47, East Jones Road,
 SAIDAPET, MADRAS-600 015.

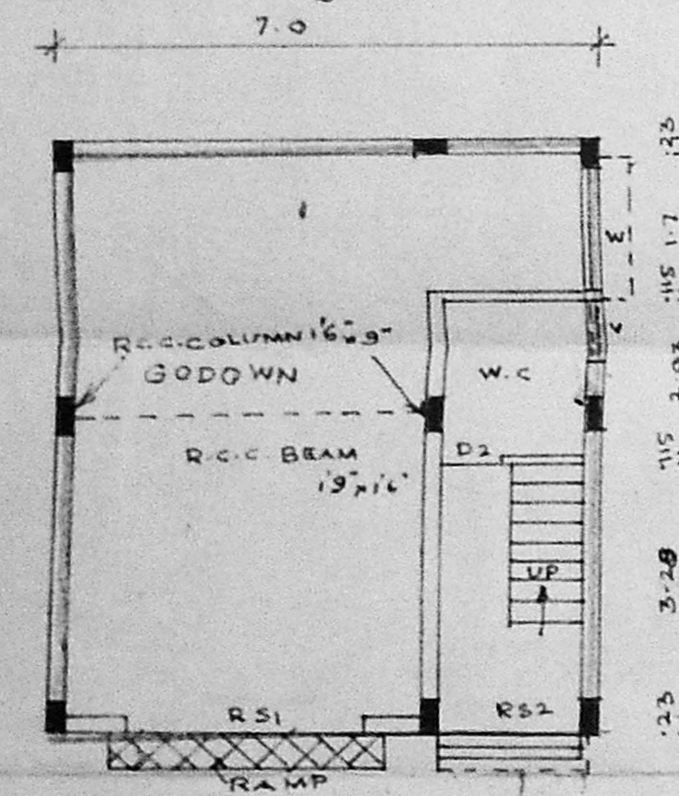

GROUND FLOOR PLAN

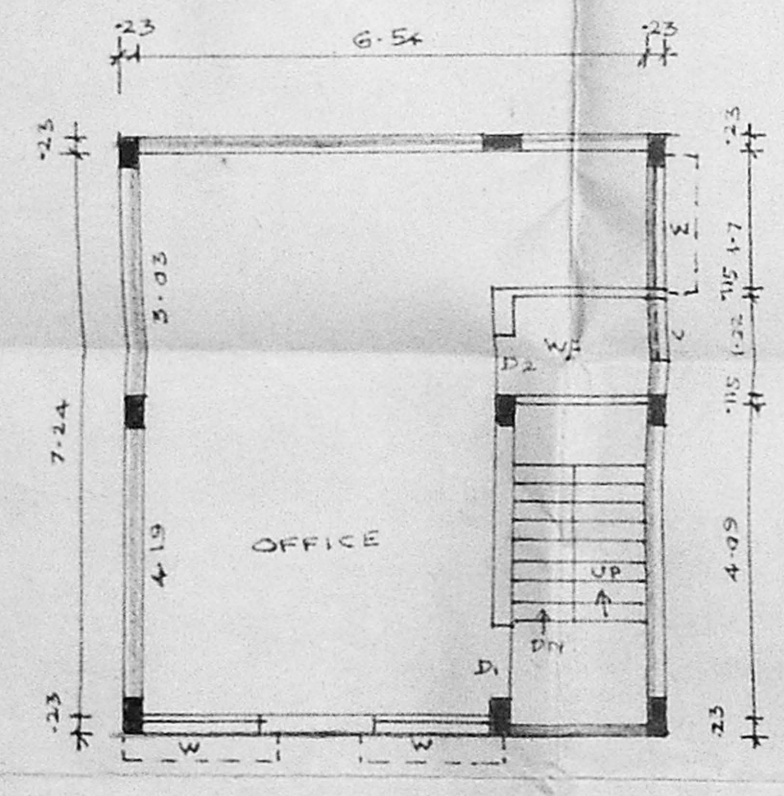

FIRST FLOOR PLAN

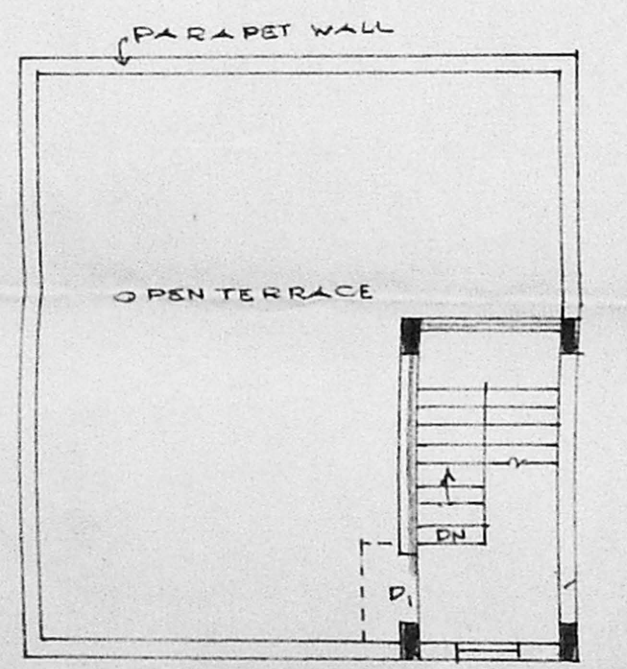

TERRACE FLOOR PLAN

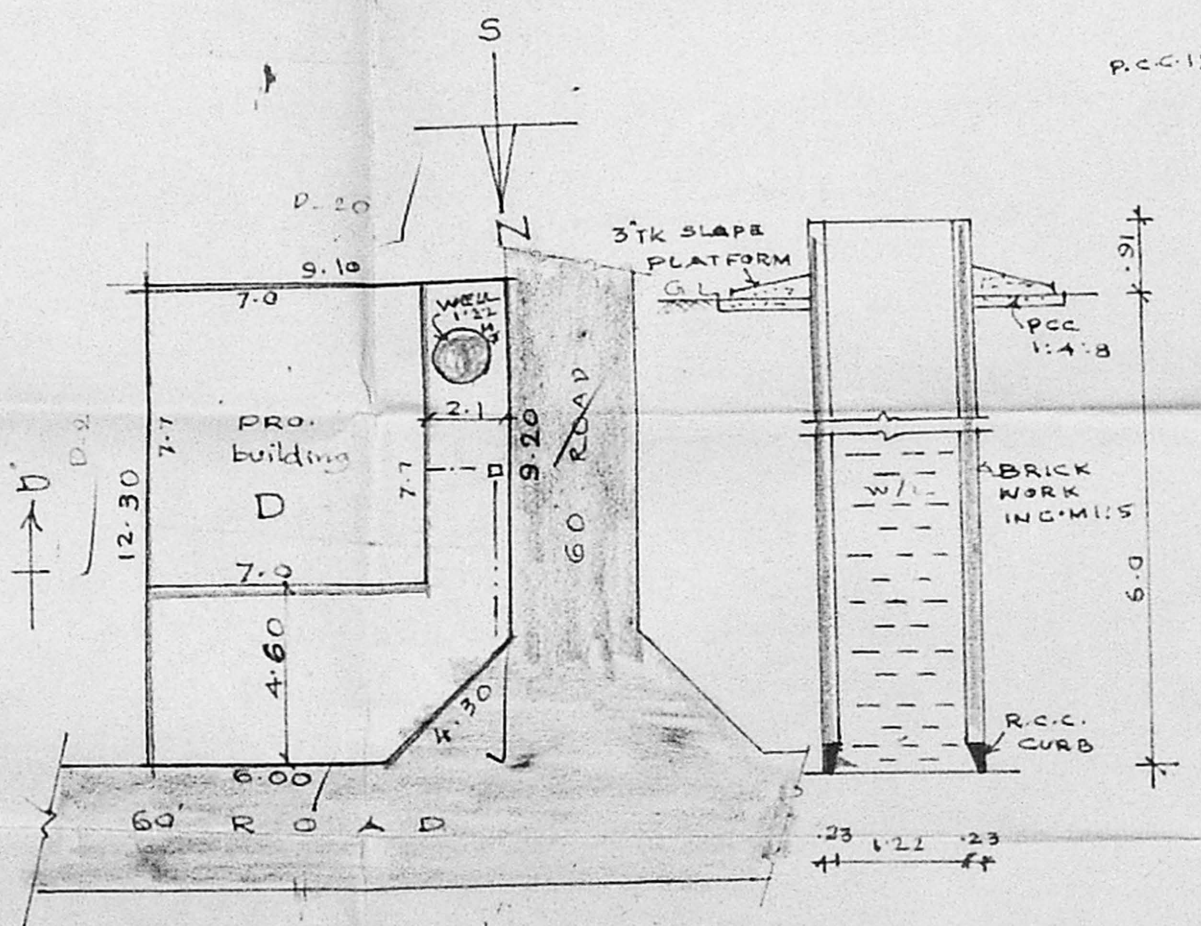

SITE PLAN

SCALE: 1:200

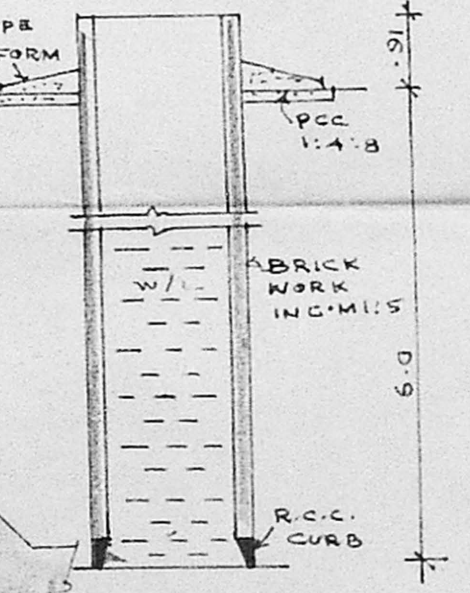

SEC. OF WELL

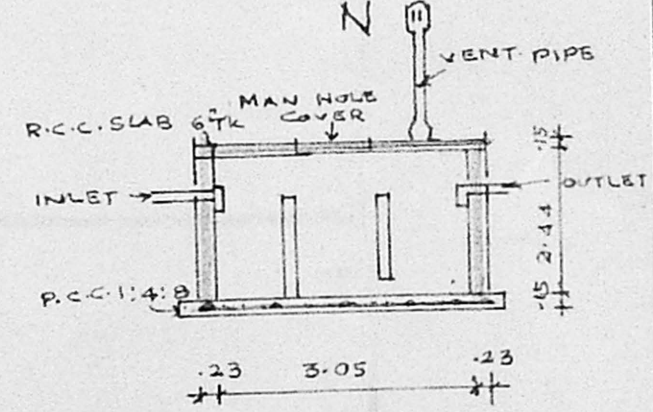

PLAN & SECTION OF SEPTIC TANK